

What are the parts of a basic audio system?

- Stored source material
- Digital to Analog conversion
- Transmission to an amplifier
- Amplification
- **Electrical to acoustical transducer (a speaker)**
- Transmission through the air to the listener's ear
- The condition of the listener's hearing

Design considerations

- Power / efficiency
- Distortion
- Frequency response & signal processing

Some review

- Humans can hear vibrations that are oscillating at frequencies between 20 Hz and 20,000 Hz. Frequencies below are “infra-sonic” (elephants) and those above are “ultra-sonic” (dogs). The speakers should reproduce all the frequencies without any reduction or enhancements. This is almost impossible, but it is the goal.
- The speakers should not distort the signal. Most speakers are pretty good at not distorting the sound, as long as they are not over-driven.
- The wavelength of the traveling sound waves produced by the speakers is important. Recall (from basic physics or EM class, if you’ve had it) that “frequency x wavelength = speed”: $f \cdot \lambda = c$. The speed of sound in air is 343 m/s (= 767 mph). So audio wavelengths ranges from about 2 cm to 20 m — quite a spread.
- Waves can reflect, diffract, refract, and interfere. So the construction and shape of the room can have a big effect on how the speakers sound. Also, the placement of the stereo pair relative to the listener has an effect. These are important topics, but we will not delve into those in this discussion.

Human ear

Our ears respond to sounds traveling through the air. The wave is channeled into the ear canal and the varying acoustic pressure causes the thin membrane of our ear drum to vibrate. This information is transferred along until it reaches our brain for processing.

Two key considerations: frequency (pitch) and sound pressure level (loudness).

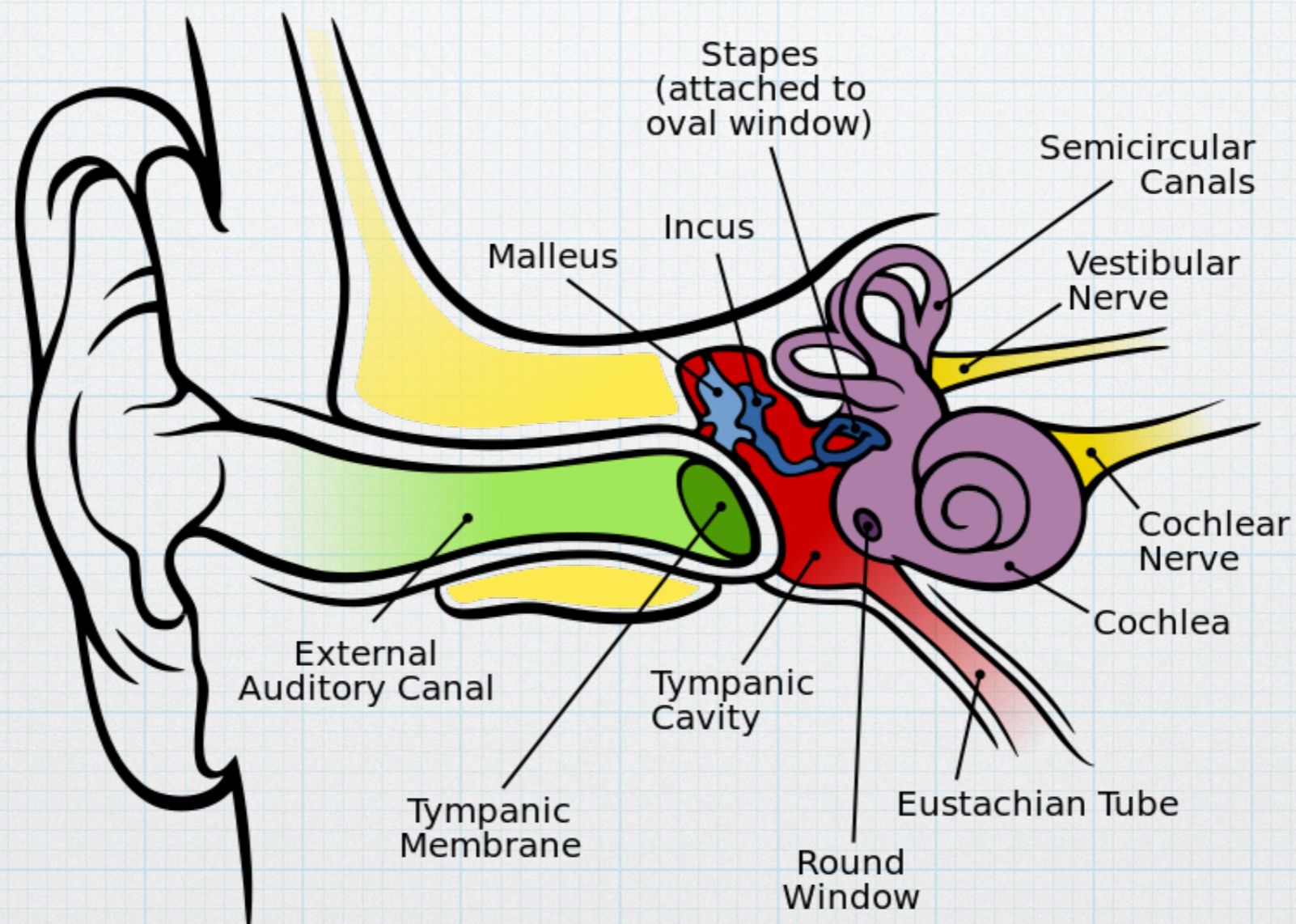

Speaker driver

- We need the “inverse” of an ear drum to create the acoustic wave – a transducer that takes electrical energy and turns it into acoustic (mechanical) energy by vibrating a membrane.
- The most common method for creating sound is to use magnetic forces to move a paper or plastic “cone” that will generate the acoustic waves. Again from basic physics, two magnetic fields with opposing polarities will have an attractive force and similar polarities will have a repelling force.
- The outside rim of the cone is firmly attached to a frame to fix it in position.
- A cylindrical permanent magnet is attached to the frame, lined up with the center of the cone.
- A cylindrical electromagnet coil (voice coil) is attached to the center of the cone, with its axis aligned with the axis of the permanent magnet.



- The audio signal from the amplifier is applied to the electromagnet. The current creates a field in the electromagnet that interacts with the fixed field of the permanent magnet, causing the electromagnet, which is attached to the cone to move in response. The electrical signal is converted into matching mechanical motion.
- A speaker is essentially an electric motor, optimized for linear motion rather than rotary motion.
- The magnets could be reversed, with the permanent magnet attached to the cone and voice coil held stationary. But permanent magnets are much heavier than a coil and the motion of the cone would be affected.
- There are many more details involved in the mechanical construction and the arrangement of the magnets, but his fundamental arrangement is the basis for the vast majority of speakers, from the tiniest earbuds to the biggest concert-level woofers.
- Fun fact: like most transducers, a speaker works both ways. If you move the cone, it will produce a current in the voice coil — it could be used as a microphone. Albeit a very poor one.

Speaker impedance

- The audio amplifier is attached to the voice coil. So the amp “sees” the impedance of the coil, consisting of the wire resistance and the inductance of the coil.
- $Z_s = R_e + jX_e = R_e + j\omega L_e$
- As an inductive impedance, the magnitude increases with frequency.
- Speaker impedance is usually specified as being either 4- Ω or 8- Ω . The actual of R_e is usually a bit smaller than this. The value is meant to include some effect of L_e .

Power

If we ignore the inductance, and treat the input of the speaker as a simple resistance, the power relationship is simple. And very restrictive in terms of the DC supplies that power the amp.

$$P = v \cdot i = \frac{v^2}{R} = i^2 R.$$

The amp must be able to provide lots of voltage *and* current.

	4 Ω		8 Ω	
v (V)	i (A)	P (W)	i (A)	P (W)
0.5	0.125	0.0625	0.0625	0.0313
1	0.25	0.25	0.125	0.125
4	1	4	0.5	2
8	2	16	1	8
16	4	64	2	32
24	6	144	3	72

Size matters

- The power in a wave is proportional to the square of the amplitude and the square of the frequency, $P \propto A^2 \cdot f^2$.
- Low-frequency sounds — bass, drums, etc. — require a large amplitude in order to have sufficient audio power. This means a big cone, a large mechanical frame, and bigger magnets. A large electrical input power is required to move the large mechanical components.
- Large mechanical components will vibrate just fine at lower frequencies, but will begin to lag at higher frequencies.
- Higher-frequency sounds don't require as much amplitude in order to generate sufficient sound-wave power. The cone and other components can be much smaller. The smaller mechanical size allows for higher-frequency vibrations.
- However, the reduced displacement of a small speaker makes it difficult to create much low-frequency power.
- Each speaker has a natural “frequency response” that depends on the overall size of the speaker.

- Low frequency
- Low-pass response
- Woofer (sub-woofer)
- 6 inches and larger

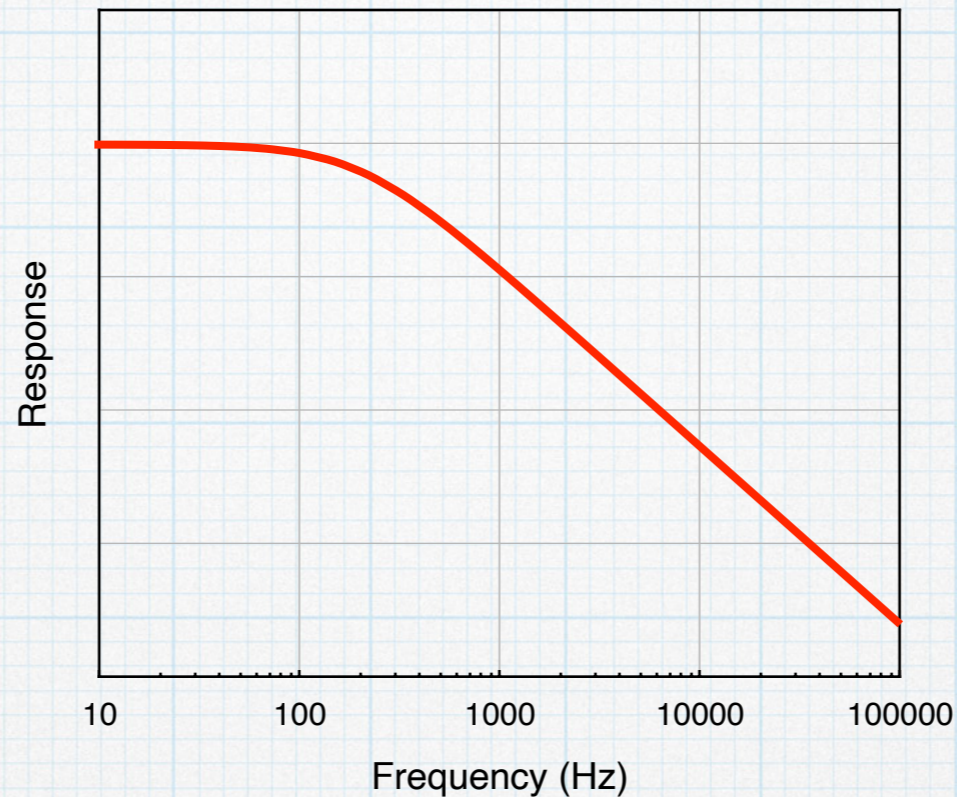

- High frequency
- High-pass response
- Tweeter
- 2 inches and smaller

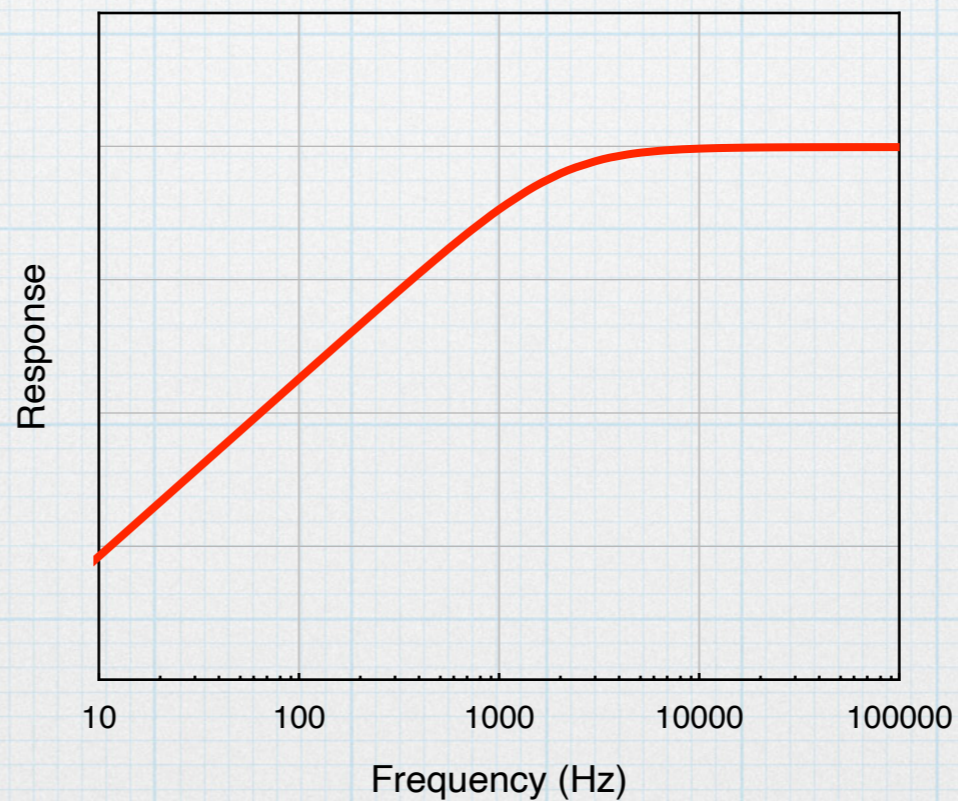

- Mid frequency
- Band-pass response
- Mid-range
- 2 inches to 6 inches

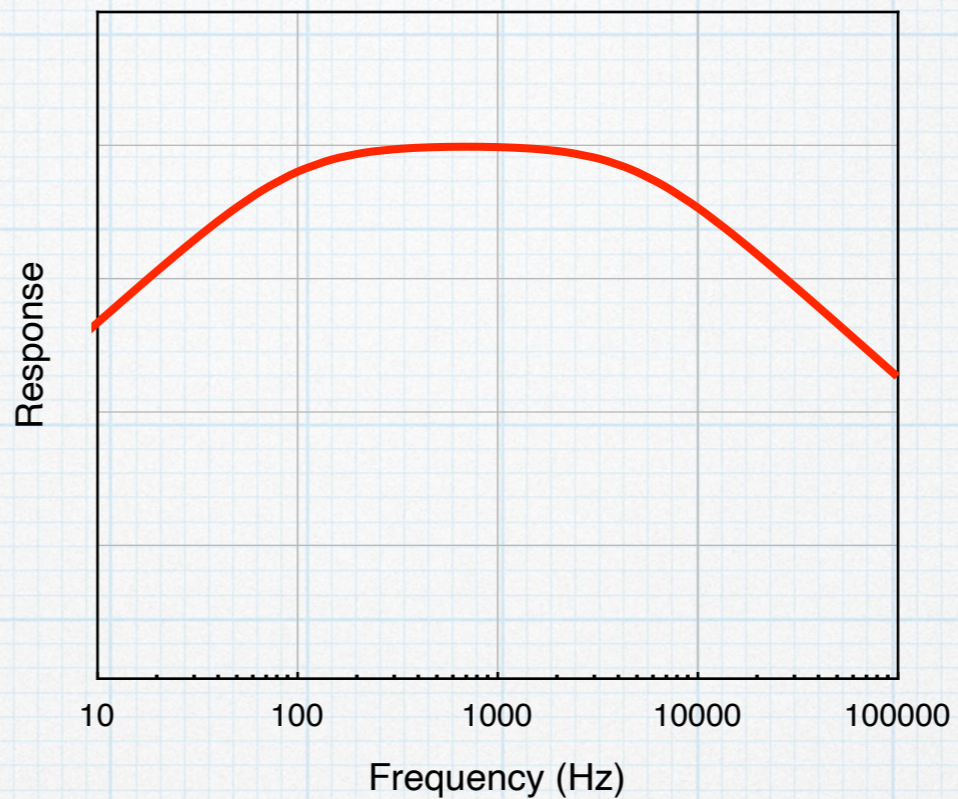

Drivers of various sizes, ranging from 0.75 inch in lower left to 12 inch at right.



It is possible to use a single driver to cover the entire frequency range — a medium-sized mid-range could do a passible job. But it will not produce high-quality sound, since the low and high ends will be diminished. There will be less bass and treble. The sound will be recognizable, but it will not be “good”.

To produce better sound, several differently sized drivers can be combined to better cover the entire frequency range.



A mid-range and a tweeter can be combined (MT) to make a bookshelf speaker. Or maybe even two mid-range drivers and one tweeter (MTM).

Even better is to add a woofer to the set to make a three-way (WMT) speaker.



Of course, it is quite common in current systems to include a separate sub-woofer, with a large driver optimized for very low frequencies, < 60 Hz.

Cross-over network

- In a multi-driver speaker, it is best to divide the incoming signal such that the woofer receives only the low-frequency part of the signal, the tweeter receives only the high-frequency part of the signal, and the mid-range (if there is one), receives only middle frequencies.
- Even though the woofer works best at low frequencies, it will transmit any high frequencies as best it can. The poorer-quality high frequencies coming woofer can interfere with those same frequencies coming from the tweeter, diminishing the overall sound quality. The same is true for the other drivers and their frequency ranges.
- To separate the signal, we use a *cross-over network*, which is set of filter circuits that divide the signal into low-, mid-, and high-frequency ranges.
- The filter circuits are combinations of capacitors and inductors, arranged to produce either low-pass, high-pass, or band-pass responses. The values of the components determine the frequencies at which the break points occur. The design of filter circuits is not hard, but it does require knowledge learned in EE 230.

Cross-over network

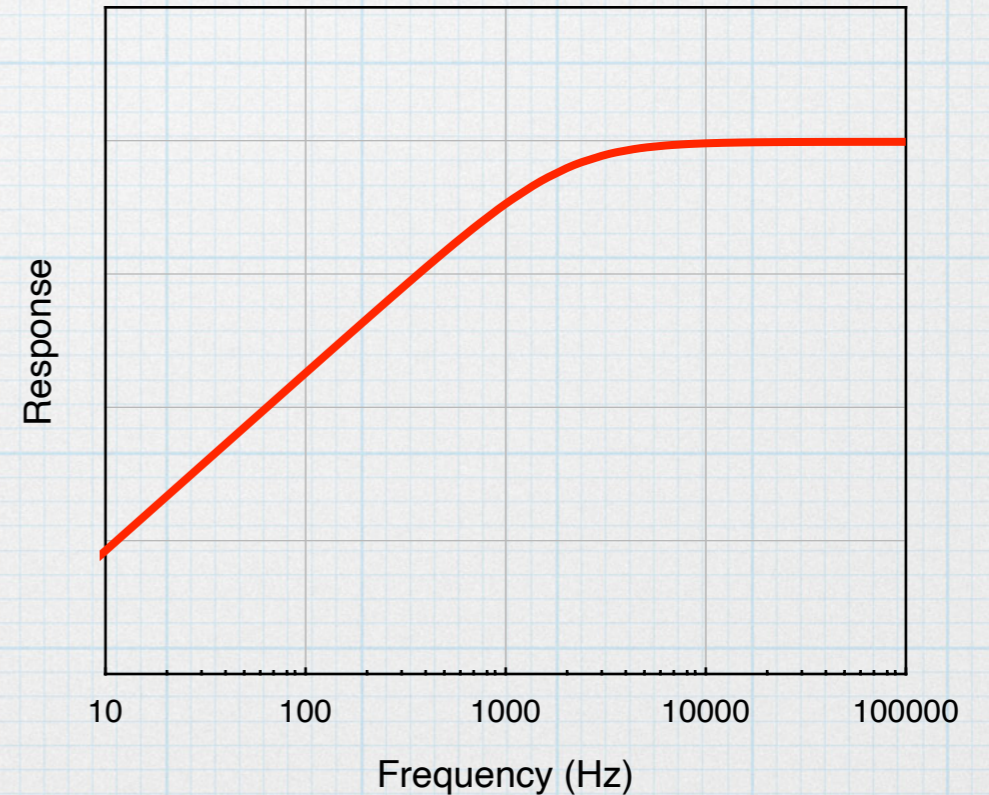
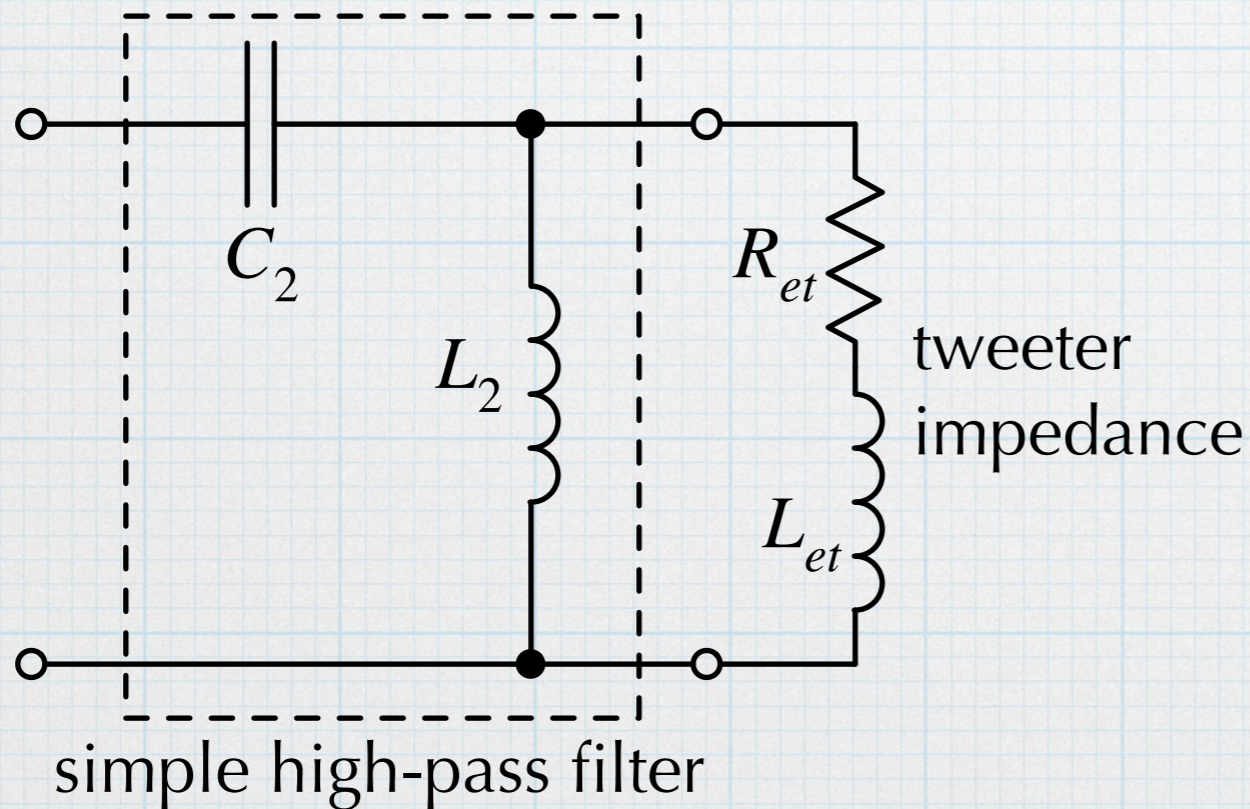
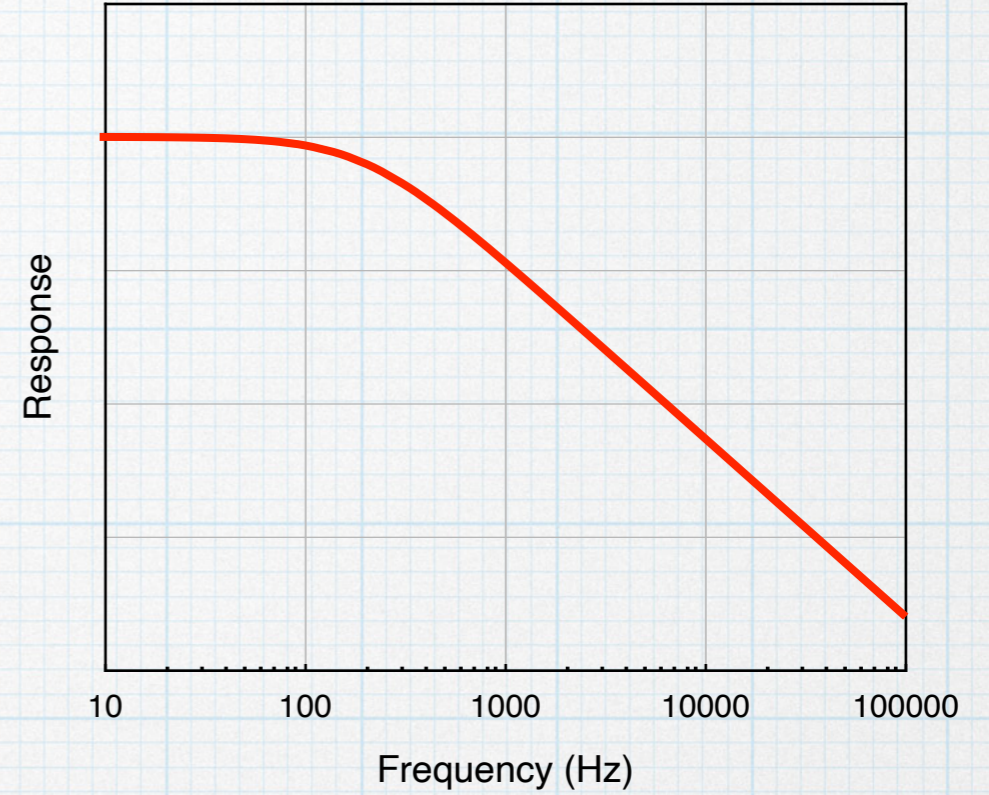
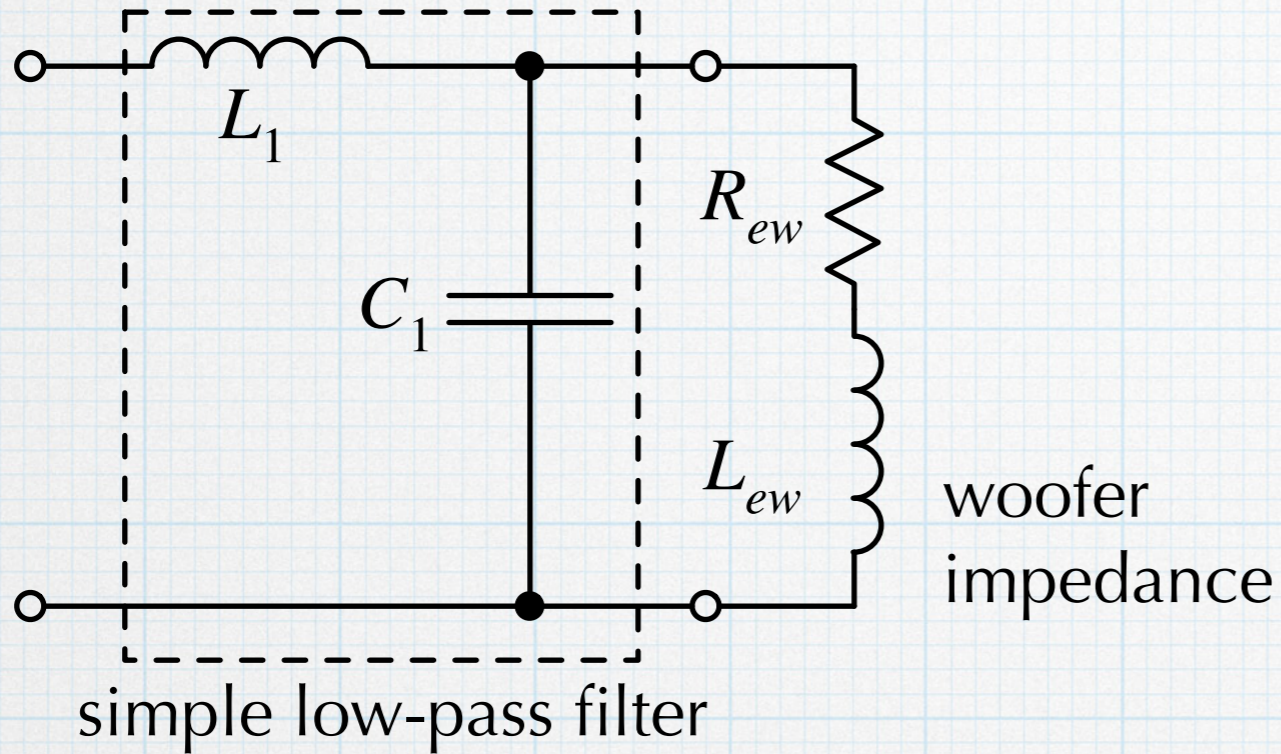

A mid-range driver would need a band-pass filter.

Enclosure

- If a driver is simply left “open”, sound will transmit in both directions. The sound traveling from the back will reflect off surfaces and interfere with the waves traveling forward. This is probably bad, since the sound quality will be diminished.
- By enclosing the drivers in a box, the sounds waves traveling from the back of the driver will bounce around inside the box and dissipate due to interference.
- The box itself introduces a *resonance frequency*, which affects the performance of the lower-frequency drivers. The size of the box is chosen so that the resonance frequency does not affect driver performance.
- The box may include an opening or *port* to reduce the sound pressure level inside the box. This usually improves the overall sound. Choosing the correct port size is part of designing the resonance frequency of the enclosure.

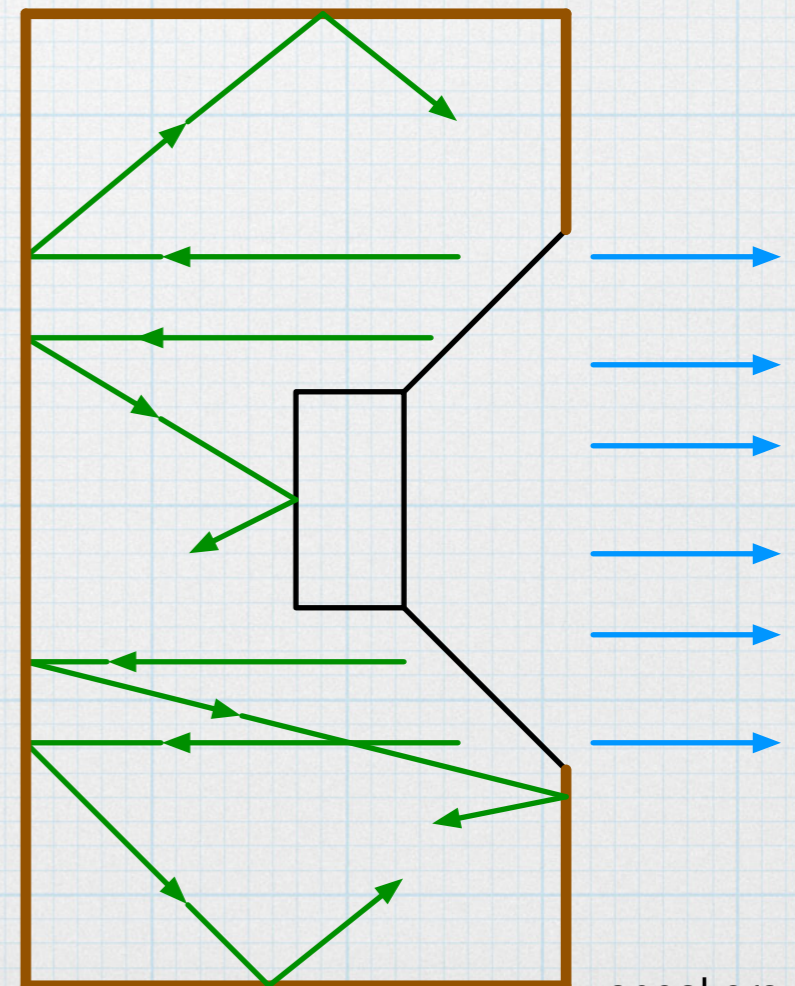
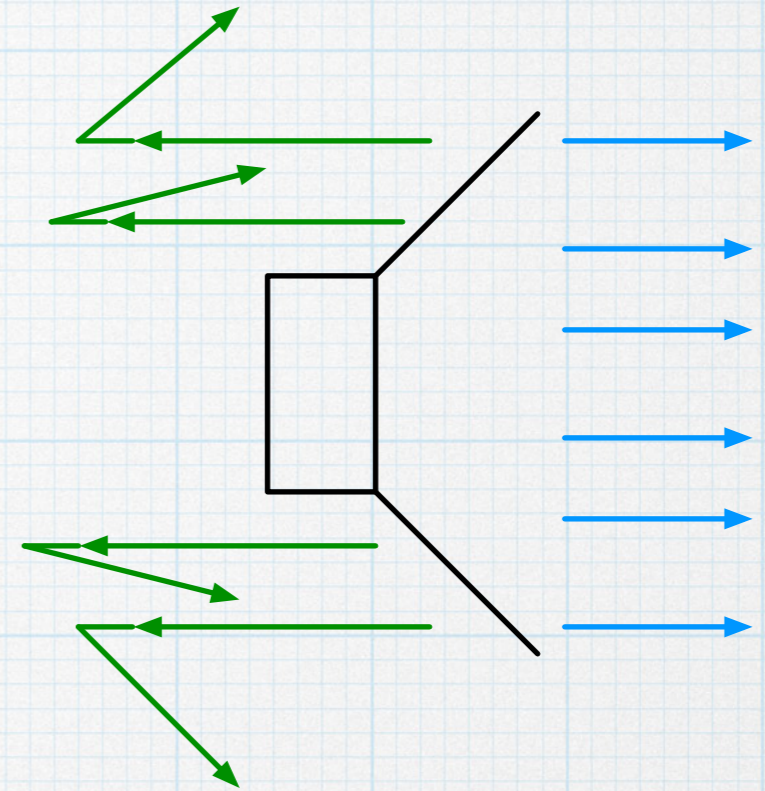

Example enclosures



In addition, the enclosure may include some sort of “filler” — think pillow stuffing — to help deaden the sound waves in the enclosure and improve sound quality.



Mono, stereo, and more

Mono — a single speaker. OK for spoken audio. Generally, won't bother with making a multi-driver setup.

Stereo — two speakers for separation to create “stereo stage”. Much better for listening to music. When the music is recorded, there are left and right “channels” recorded. These separate signals are sent to the left and right speakers. The sound waves produced by the two speakers combine to provide a much “richer” sound. Can be WMT or MT + a sub-woofer. (2.1 system.)

5.1 — six channels for home theaters. The 5 are multi-driver speaker, probably of the “MT” variety.

- center speaker, which carries most of the spoken content.
- left and right side speakers for enhance spatial effect. Also can be used if listening to just music and not movie environment.
- left and right rear speakers — also for enhance spatial effect.
- A sub-woofer for low frequencies, which be placed most anywhere.

7.1 — Like 5.1, but more. Includes “side-left” and side-right” speakers.

Dolby Atmos — pure signal-processing. Divides the sound into an “infinite” number of channels and maps that onto the speakers available in a particular system.

Example 5.1 system



Klipsch.

Various videos showing how speakers work. They all similar to the video linked on slide 3, but each has some different details that are interesting. (There are probably a million more speaker videos available on the internet.)

1. https://www.youtube.com/watch?v=AP2Nu4MZJR_s
2. <https://www.youtube.com/watch?v=UNYSFIQcRnE>
3. <https://www.youtube.com/watch?v=jhg90zsjqt4>
4. <https://www.youtube.com/watch?v=RxdFP31QYAg>
5. <https://www.youtube.com/watch?v=YbYg-FmGolg>
6. <https://www.youtube.com/watch?v=23q3zoKiuGs> (follow-on to 5)